

Honeywell

Portable Evaporative Air Cooler User Manual (Web)

Read and save these instructions before use

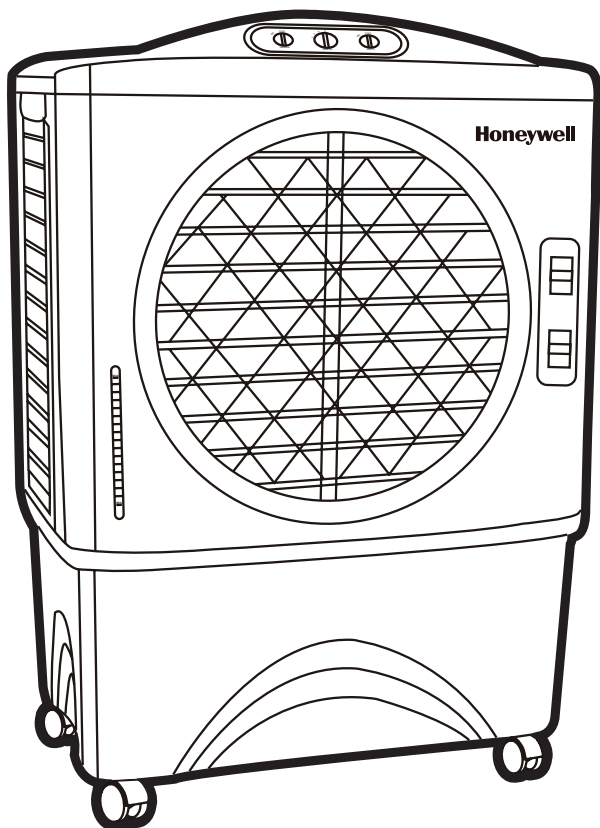

Model:
CL48PM/ CO48PM

PARTS DESCRIPTION

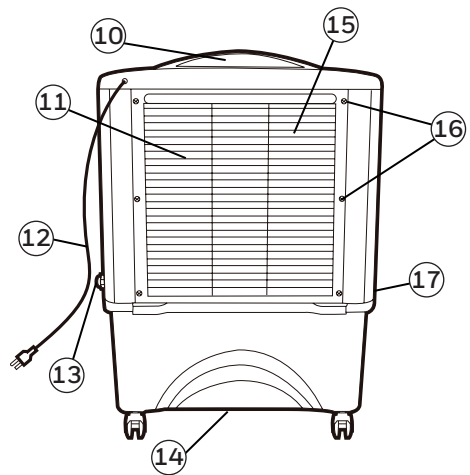
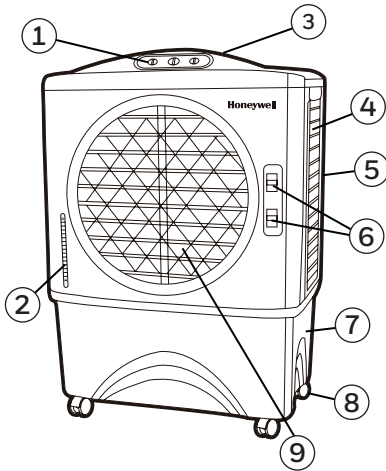

1) Control Panel

2) Water Level Indicator

3) Water Inlet Hole

4) Handle

5) Left Side Grill

6) Lever for Horizontal Louvers

7) Water Tank

8) Casters

9) Louvers

10) Water Fill Door

11) Rear Grill

12) Power Cord & Plug

13) Water Inlet Valve

14) Drain Plug

15) Honeycomb Cooling Media

16) Rear Grill Screws

17) Right Side Grill

WARNING -- READ AND SAVE THE AIR COOLER SAFETY & MAINTENANCE GUIDE AND USER MANUAL BEFORE USING THIS PRODUCT. FAILURE TO FOLLOW THESE INSTRUCTIONS MAY DAMAGE AND/ OR IMPAIR ITS OPERATION AND VOID THE WARRANTY. IN CASE THERE IS ANY INCONSISTENCY OR CONFLICT BETWEEN THE ENGLISH VERSION AND ANY OTHER LANGUAGE VERSION OF THE CONTENT OF THIS MATERIAL, THE ENGLISH VERSION SHALL PREVAIL.

WARNING: FOR OUTDOOR MODEL CO48PM (in USA), USE ONLY ON GFCI PROTECTED RECEPTACLES.

USE & OPERATION

CONTROL PANEL

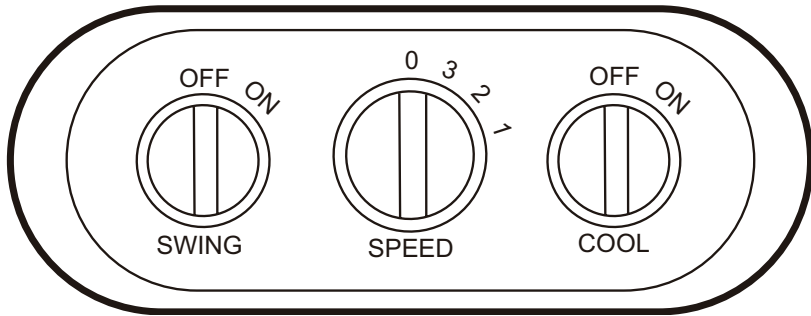

FUNCTION BUTTONS

SPEED / ON - OFF

Connect to the power supply and turn the SPEED knob. The fan will start. Change the speed from 3 to 1 (1 for Low, 2 for Medium and 3 for High fan speed). To switch OFF the unit, turn the SPEED knob to 0.

COOL

You must add water before operating the unit on Cool mode. Turn the COOL knob to the ON position to activate evaporative cooling. The water pump will operate and you will feel the cooler air after the Honeycomb Cooling Media is completely wet.

SWING

Turn the SWING knob to the ON position to activate the movement of the louvers. The louvers will begin to move left to right automatically. Vertical Air Flow - You can manually adjust the lever located at the front of the unit to change vertical air flow.

COOLER LOCATION

Make sure to position the air cooler correctly before you set up and start using the product. Please refer to the COOLER LOCATION section of the separate Safety & Maintenance Guide.

FILLING WITH WATER

It is ideal to use the Continuous Water Supply Connection to run the unit for long periods of time without refilling the tank. This also helps prevent pump failure in case the cooler is running with inadequate water in the tank.

CAUTION: Unplug the unit from the electrical power outlet before filling or emptying the water tank.

Continuous Water Supply Connection:

For a continuous water supply, you will need a garden hose that is connected to a main water supply.

Note: The garden hose is not included. Please make use of a garden hose which is compatible with the unit connection.

- Locate the male connector at one end of the garden hose. Insert the garden hose connector into the water inlet valve of the cooler. Screw and tighten the water inlet valve onto the threaded part of the garden hose connector, making sure the hose connector is secured to ensure there will be no leaks. If there is leakage, the hose and the water inlet valve may not be connected properly. Try to disconnect, replace and tighten the water inlet valve again.
 - When the connection is secured, turn ON the water supply and the water will flow into the water tank of the cooler.
 - The cooler is now set so the water refills automatically.
 - When the water tank is full, the water inlet valve will automatically stop the water supply from overflowing.
 - Please open the water valve for minimum flow as too much pressure could damage the inlet pressure control system.
- WARNING:** The maximum water inlet pressure is 0.5 MPa.

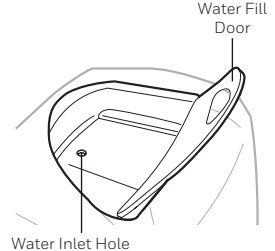
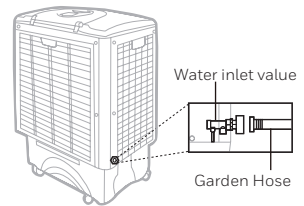

Manual Water Tank Refill:

- Using a portable container or a garden hose, you can refill the water tank manually by pouring water into the water tank through the water inlet hole located at the top of the air cooler.
- Check the water level indicator to know when the water tank is full. Do not fill water above the "Max." water level mark to avoid water droplets collecting on the louvers.

WARNING: Always ensure the water in the water tank is above the minimum (Min.) water level mark for both Continuous & Manual Water Refill. Running the unit in Cool mode with inadequate water may cause pump failure.

USE & OPERATION (CONTINUED)

FILLING WITH WATER (CONTINUED)

Note: The water capacity refers to the total volume of water that can be contained within the air cooler water tank and water distribution system. The water capacity in the tank at the “Max.” indicator level may be lower than the actual water capacity of the air cooler.

WARNING: Do not fill water tank with dirty water or salt water. This can damage the unit and Honeycomb media.

CLEANING & DRAINING THE WATER TANK

If the cooler will not be used for a long period of time, please refer to the STORAGE & MAINTENANCE GUIDELINES located in the separate Safety & Maintenance Guide.

WARNING:

Before cleaning the unit, switch the unit OFF and disconnect from the electrical socket.

- Move the unit to a location where the water can be drained. Remove the cap from the Drain plug located at the bottom of the unit. Allow the tank to empty.
- Refill the water tank with clean water, up to the maximum level and drain it completely.
- Use a damp cloth to remove the dirt and dust from the surface of the unit. Never use corrosive elements or chemicals to clean this product.
- When the product is not in use, store the unit in a dry place away from direct sunlight.

CLEANING THE HONEYCOMB COOLING MEDIA

- The appliance is supplied with three Honeycomb Cooling Media pads.
- The Honeycomb Cooling Media are located inside the Rear and Side Grills. Follow Steps 1 to 5 for instructions on how to remove them from the unit for cleaning and maintenance.
- Do not run the unit in COOL mode with stale water in the tank. You must empty the water tank and refill with fresh water, especially if the tank has not been cleaned in a long time.
- The cleaning frequency for the Honeycomb media depends on local air and water conditions. In areas where the mineral content of water is high, mineral deposits may build up on the Honeycomb Cooling Media and restrict air flow. Draining the water tank and refilling with fresh water at least once a week will help reduce mineral deposits. If mineral deposits remain on the Honeycomb Cooling Media, the media should be removed and washed under fresh water. The media should be cleaned every two months or sooner, depending on your needs.
- For best results allow the Honeycomb Cooling Media to dry after each use by turning off the cool function 15 minutes before turning the unit off.

CLEANING THE HONEYCOMB COOLING MEDIA (CONTINUED)

Removing the Honeycomb Cooling Media:

1. Remove the screws from the Rear Grill of the Air Cooler.
2. Carefully pull out the Rear Grill from the Air Cooler.
3. The Honeycomb Cooling Pad is secured on the Rear Grill by two Horizontal Bars that are fixed in place by two screws on the Left and Right Sides of these Horizontal Bars. Remove these screws to release the Horizontal Bars.
4. Pull out the Honeycomb Cooling Pad by sliding it out from the Rear Grill. Replace with the new Honeycomb Cooling Pad by sliding into the grooves of the Rear Grill until it fits comfortably and securely in place on the grill. Replace the Horizontal Bars back onto the Rear Grill by replacing the Left and Right Side screws and tightening them in place. This secures the Honeycomb Cooling Pad in place on the Rear Grill.
5. Repeat steps 1 to 4 to remove the Honeycomb Cooling Pad on the Left and Right Side Grills.

WARNING: DO NOT operate the Air Cooler when any or all of the Rear or Side Grills are removed from the Air Cooler, or if there is a loose-fitting Rear or Side Grill. Doing so can cause serious injury or dangerous electrical shock.

Step 1:

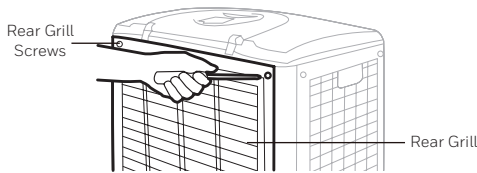

Step 2:

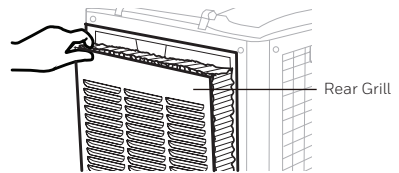

Step 3:

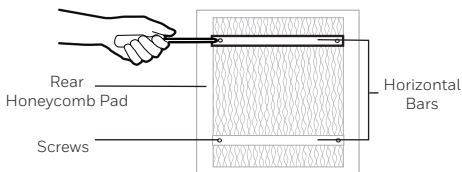

Step 4:

